

Conquering SMT Stencil Printing Challenges with Today's Miniature Components *Is Electroform Technology the Right Solution?*

By Robert F. Dervaes, V.P. Technology and Engineering, Fine Line Stencil, Inc., Jeff Poulos, V.P. of Manufacturing and Sales, Alternative Solutions, Inc., and Scott Williams, Product/Account Manager, Ed Fagan, Inc.

The technological advancement of component and PCB technology from through-hole to surface mount (SMT) is a major factor in the miniaturization of today's electronics. Smaller and smaller component sizes and more densely packed PCBs lead to more powerful designs in much smaller product packages. With advancement, however, comes a new set of challenges in building these smaller, more complex assemblies. This is the challenge original equipment manufacturers (OEM) and contract manufacturers (CM) face today.

One of the challenges facing OEMs and CMs in building assemblies with miniature components is the stencil printing process. Many of today's designs incorporate a mix of miniature and much larger components. Manufacturing engineers are faced with the dilemma of choosing a thinner stencil foil to ensure solder paste release for the miniature components or a thicker foil to ensure sufficient solder volume for the larger components. With a standard laser-cut stencil using 300 series stainless steel, one would have to make that difficult choice. An electroformed stencil gives more options in balancing release for miniature components and volume for larger ones due to its ability to successfully print smaller components without reducing the foil thickness. However, many have difficulty justifying the 3X-4X cost increase and added schedule delay for an electroformed stencil, especially with more and more companies moving to a low-volume, high-mix array of jobs. Faced with these two options, is electroformed technology the right solution or have technological advancements allowed new developments in stencil technology?

This article discusses new developments in stencil laser and material technology and shows how these advancements, when combined, provide comparable and cost-effective alternatives to traditional electroformed stencils. The results are improved yields, cycle time reductions, and significant cost savings.

Brief History of Stencil Technologies

Before stencil lasers were developed, the only manufacturing methods for producing solder paste stencils were silk screening and chemical etching. The etching process was time consuming and hazardous due to the powerful chemicals used to etch the metal. There also were limitations as to how small a stencil aperture could be effectively produced during the etching process.

Chemically etched stencils typically were limited to component pitches no smaller than 0.025" and registration of the stencil apertures to the SMT pads was not precise enough as component sizes decreased. These limitations would not allow chemical etching to keep pace with the rapid advancements in component and PCB design.

In the early 1990s, lasers started being used to produce solder paste stencils. This new technology was a major improvement over traditional silk screen and chemical etching in producing stencils quicker, cheaper, and with much smaller aperture sizes. The motion systems on the laser systems also provided a much higher positional accuracy for the stencil apertures,

leading to much better alignment between the stencil and PCB. With these significant improvements, component pitches down to 0.016" could easily be cut.

While these laser systems are capable of producing high-quality solder paste stencils for the majority of assemblies, advancements in component and PCB design continued. With the introduction of components like "micro BGA (μ BGA)," "quad flat no-lead (QFN)," and 0201s, laser-cut stencils struggled to produce acceptable solder paste release for these very small apertures without a reduction in the thickness of the stencil foil. This was not always an acceptable solution as the larger components would have insufficient solder volume. Enter electroformed technology. Electroformed stencils are produced by electroplating Nickel on top of a Stainless Steel substrate under various specialized and challenging conditions. The plated Nickel film is later removed from the Stainless Steel substrate resulting in the Nickel foil that is the electroformed stencil. This manufacturing process produces an exceptionally smooth stencil aperture wall compared to chemically etched and traditional laser-cut stencils. The smoothness of the aperture wall is a vital component of a high performance stencil allowing printing of smaller apertures without reducing the foil thickness.

For many years, electroformed stencils have been the premier solution for these new, challenging assemblies. However, the assembly industry as a whole is being driven to turn product faster and cheaper. Electroformed stencil prices typically are 3X-4X higher than traditional laser-cut stencils and it takes longer to produce an electroformed stencil. In most cases, the turn time is 3 to 4 days and this technology is limited to only a few shops that have the knowledge and expertise in plating very thin Nickel foils. Many OEMs and CMs need stencils produced and shipped the day the order is placed in order to meet their schedule. The higher cost and longer lead-time of electroformed stencils make it more difficult to meet the schedule and cost demands of today's assemblies. How does one determine if a traditional laser-cut or electroformed stencil is required?

There are two formulas used to determine whether or not the smallest aperture on a stencil will have acceptable solder paste release with a given stencil technology. These are *surface area ratio* and *aspect ratio*. The *surface area ratio* can be used for any stencil aperture shape and is the contact area between the paste and PCB pad ($L \times W$) divided by the contact area between the paste and stencil ($(2 \times L \times T) + (2 \times W \times T)$).

The *aspect ratio* is limited to rectangular, square, and round stencil apertures and is the smallest dimension of an aperture

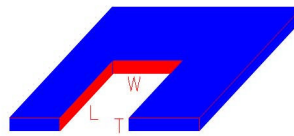

ASPECT RATIO = $W/T \geq 1.5$
AREA RATIO ≥ 0.66 (Historical Limit)
AREA RATIO ≥ 0.5 (Electroformed)
AREA RATIO = $(L*W)/((2*L*T) + (2*W*T))$

(width (W) for rectangles and squares, diameter for circles) divided by the thickness (T) of the stencil foil (historically the aspect ratio has been limited to 1.5 for rectangles and 2.5 for squares and circles). Since the majority of stencils have a mixture of aperture shapes, including custom shapes (homeplates) for 2-pin components, the *surface area ratio* formula is the most accurate when determining which stencil technology to utilize.

To successfully print small components without reducing the stencil foil thickness, the stencil must be capable of producing acceptable solder paste release at as low a surface area ratio as possible. The historical limit of chemically etched and traditional laser-cut stencils has been a

surface area ratio of 0.66. In the case of electroformed stencils, the limit has been improved to 0.5. The lower surface area ratio limit of electroformed stencils is the reason for selecting this technology when facing challenging assemblies.

With all of the advancements in component and PCB design, has advancement in the stencil industry remained stagnant or has technological improvement benefited this industry as well? Is the stencil industry now in a better position to provide solutions for printing miniature components while meeting customers' tighter delivery and cost requirements?

New Developments in Stencil Laser Technology

Stencil laser technology has seen continuous advancement over the past 10 years. The majority of advancement has been in linear motor technology, leading to improvements in the cutting speed of stencil lasers. Until recently, *the source of the laser beam has remained the same* with reliance on lamp pumped technology. The lamp pumped technology is comprised of flash lamps, YAG rods, mirrors, and focal lenses. With this technology, the smallest diameter laser beam possible was approximately 40 μm . While this diameter beam is fine for the majority of stencil designs, the energy density with a 40 μm beam diameter is not high enough to produce the smoothest aperture walls when cutting stencil apertures for miniature components.

In the past two years, there has been a major leap forward in laser technology. The most significant development is the introduction of the Single Mode CW Ytterbium Fiber laser ("fiber laser" for short). The new fiber lasers produce shorter pulse widths, higher frequencies, and have a fully programmable pulse/pause ratio. In addition, they produce a smaller laser beam diameter of 19 microns with a corresponding 4X increase in energy density. The 4X increase in energy density significantly increases the laser beam's ability to cut through the metal and the result is a much smoother aperture wall (see picture at left).



LPKF MultiCut Fiber Laser

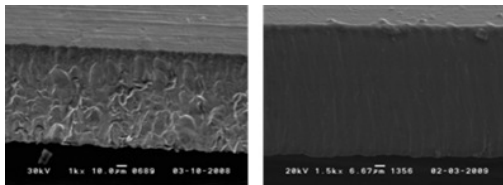

SEM Photos of SS 300 Series (left) and New Material (right) Aperture Walls

New Developments in Stencil Material Technology

Along with advancements in laser technology, there also have been advancements in stencil material technology. For many years, laser-cut stencils used either 300 series stainless steel or a higher nickel alloy (Invar Alloy 36, Alloy 42) for the stencil foil material. These are good solutions for the majority of assemblies, but their paste release performance reduces considerably when printing apertures with surface area ratios below 0.66. As a result, one would have to either increase, "overprint," the aperture sizes when selecting a thicker foil or reduce the foil thickness for acceptable prints.

Overprinting miniature components, however, is not always a guaranteed solution since the crucial surface area in the surface area ratio formula is the common metallic surface area between the SMT pad and the stencil aperture. If a PCB has a CSP component with a 0.010"

diameter pad and the stencil overprints with a 0.012" diameter aperture, the common metallic surface is still limited to the 0.010" diameter of the SMT pad. The additional paste beyond the 0.010" limit of the SMT pad is not in contact with the metallic surface and, therefore, does not contribute to pulling the paste from the stencil.

Advancements in stencil material technology include new stencil materials specifically designed for stencil laser-cutting. The *Fine Grain* material (distributed by Ed Fagan, Inc.) has a much finer grain structure (see picture at right) when compared to standard 300 series stainless steel and alloys, and contain smaller and fewer voids in the material. With smaller and fewer voids, the solder paste does not adhere as easily to the stencil walls. This is primarily due to the micro size of the voids (in some cases smaller than the particle sizes in the solder paste) that makes it more difficult for the solder paste particles to get a grip on the stencil walls. When the solder paste is pulled from the stencil as the PCB drops, release is easier and less paste residue is retained in the stencil. The easier release allows for the printing of smaller stencil apertures, without reductions in foil thickness, and the reduction in paste residue allows for an increase in the number of prints before having to clean the stencil.

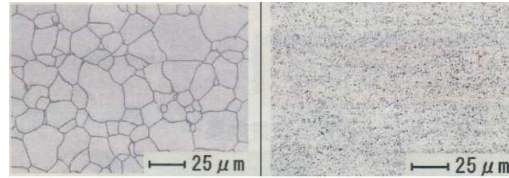

Grain Size Comparison: SS 300 Series (Left) and New Material (Right)

In addition to improved paste release for smaller apertures and much cleaner paste release throughout the entire stencil, the finer grain structure of these new materials also produces a more defined aperture edge (see picture at left) when cut with a properly tuned laser beam. As the aperture size decreases, the importance of repeatable and accurate solder paste release rises. With miniature components, small fluctuations in solder volume have a much larger impact on solder joint reliability due to the minimal solder volume required. A more defined aperture edge, along with improved paste release, leads to more repeatable and accurate solder paste release.

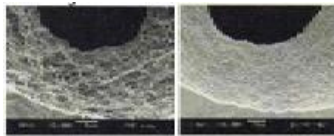

Aperture Edge Comparison: SS 300 Series (Left) and New Material (Right)

The new materials are a stainless steel composition and are rolled so thickness tolerances are extremely tight. They also have improved thermal conductivity as well as similar mechanical and corrosion resistant properties when compared to standard 300 series stainless steel. Stencil life and durability are similar to standard 300 series stainless steel stencils.

Stencil Laser and Material Technology Advancements: Performance

Technological developments in component and PCB design are beginning to outpace current stencil technology. Do these significant advancements in stencil laser and material technologies provide the current and future solutions the electronics assembly industry requires? That question is best answered through a design of experiments (DOE) comparing the new laser and material technologies with the standard stencil technologies available today.

DOE: The Viability of New Stencil Laser and Material Technology

The objective is to determine the viability of this new stencil laser and material technology and its impact on the current, and future, demands of the electronics assembly industry.

DOE Details

Test Items	
Lasers:	LPKF LPKF MultiCut (high-power Nd:YLF fiber laser , new technology) LPKF SL 600 (lamp-pumped Nd:YAG laser, current technology)
Materials:	New Fine Grain (UltraSlic™ FG) material Slic™ material Electroformed Electroformed nickel sheet with laser-cut apertures Rolled nickel sheet with laser-cut apertures SS 300 series
Solder Pastes:	Water Soluble – WS150 Type 3 and Type 5, WS157 Type 3 and Type 5 No-Clean – NC650 Type 3 and Type 5 Lead-Free – Sn100C Type 3 and Type 5, SAC 305 Type 5

Test Equipment and Parameters	
Printer:	DEK 265GSX
Blades:	DEK
Print Speeds:	50.8 mm/sec and 127 mm/sec
Separation:	0.3 mm/sec and 7 mm/sec
Print Gap:	0 (on contact)
Stencil Clean:	Every print
Inspection:	Koh Young KY-3030 3D

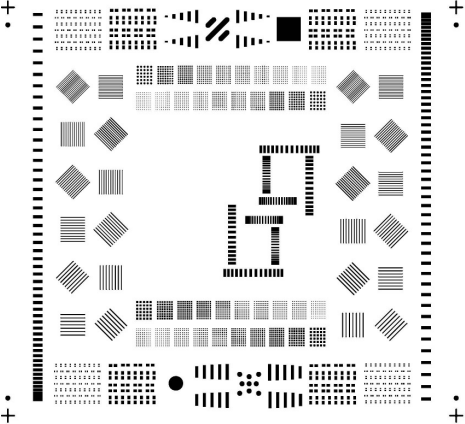
Test Board	
	
Finish:	Electroless Nickel/Immersion Gold (ENIG)
Surface are ratios:	0.17 to 15
Pad count:	4,188

The objective of the DOE is to determine the viability of the new stencil laser and material technologies. The results of the current technologies were as expected — of those, electroformed

had the best solder paste release. How did the new stencil laser and material technology compare to current stencil technologies?

New Fine Grain Performance

The surface area ratio limit for electroformed technology is 0.5. While a significant improvement over standard laser-cut stencils, materials that offer improved performance at area ratios of 0.5, and below are going to be a requirement as component and PCB technology continues to advance.

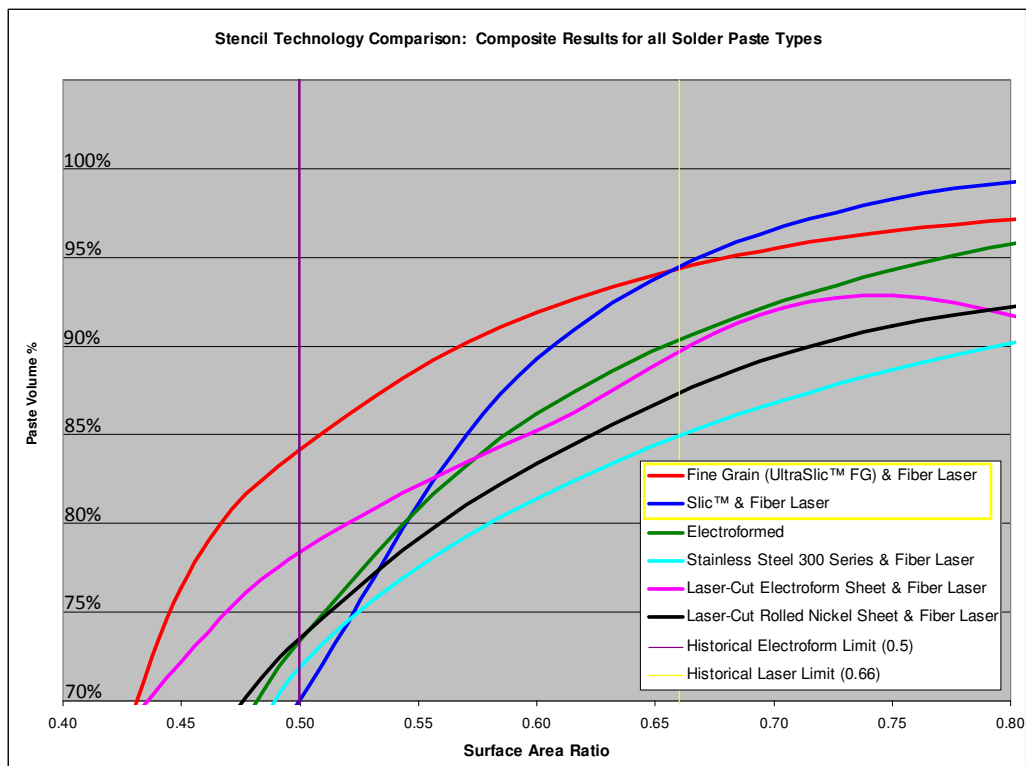

Solder Paste Volume

The results above illustrate the print performance of the various stencil technologies over the entire range of solder paste types tested. All were laser-cut on the new LPKF Multicut fiber laser, except the electroformed stencil which utilized traditional electroform technology. The electroformed stencil was the performance baseline with acceptable paste volume % at a surface area ratio of 0.5. The laser-cut electroformed nickel sheet had acceptable paste volume % down to 0.45, but its print performance quickly flattened out compared to the Fine Grain and electroformed stencils. The Fine Grain stencil had acceptable paste volume % at 0.45 and its print performance continued to outperform electroformed as the surface area ratio increased. The performance increase down to a surface area ratio of 0.45 allows the printing of even smaller components without a corresponding reduction in the stencil foil thickness. The result is additional solder paste volume for the non-miniature components, resulting in less rework and improved solder joint reliability.

Aperture Registration

As component pad sizes continue to decrease, alignment accuracy between the stencil and PCB is becoming more critical. The adhesion of the solder paste to the SMT pad is the sole force involved in pulling the paste from the stencil. Since PCBs will tend to shrink during the manufacturing process, SMT pad locations tend to be slightly short of their expected locations. Long PCBs, of course, will have significantly greater shrinkage than short PCBs.

In addition to PCB shrinkage, the electroformed stencil process uses Mylar film to create the stencil image. The film is dimensionally unstable due to its susceptibility to temperature and humidity fluctuations. Without tight temperature and humidity controls in the manufacturing area, shifts in aperture locations can occur during plotting of the Mylar film and during its use.

Since the electroform process only produces the electroformed foil, it typically has to be mounted into a stencil frame. During the electroform process, no tension is applied to the electroformed foil. When mounted into a stencil frame, tension is applied to electroformed foil by the stencil frame's polyester mesh. This tension pulls on the foil causing slight shifts in the locations of the stencil apertures. In most cases, the electroformed stencil aperture locations will be long, or further away from their expected locations. If the PCB has SMT pad locations that are short of expected locations and the electroformed stencil has aperture locations further away than expected, there can be a significant shift, or misalignment, between the stencil apertures and PCB pads.

A shift between the stencil aperture and PCB pad reduces the amount of solder paste in contact with the surface of the PCB pad. This lowers the adhesive force between the solder paste and PCB pad, effectively reducing the ability of the board to pull the paste from the stencil. Miniature components already have very low surface area ratios. The lower the surface area ratio, the more critical the alignment between the stencil aperture and PCB pad. The Fine Grain stencil in this DOE was cut in the frame on the new LPKF high-power short-pulse fiber laser. The intent was to minimize stencil aperture registration errors, thereby increasing the alignment accuracy between the stencil and PCB. The results (27 position errors for the Fine Grain stencil and 2,307 position errors for the electroformed stencil) below show a marked improvement in aperture registration when compared to an electroformed stencil.

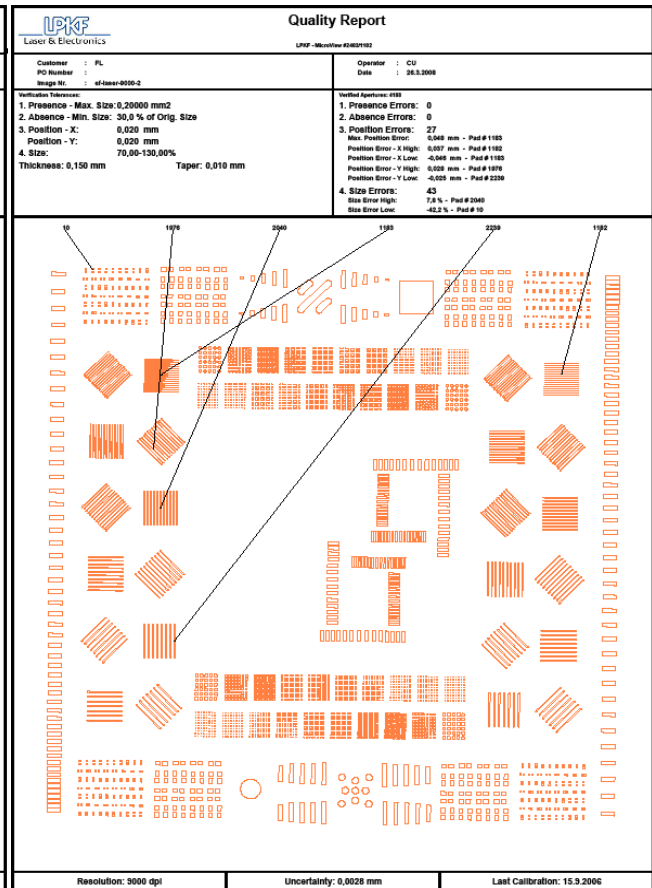
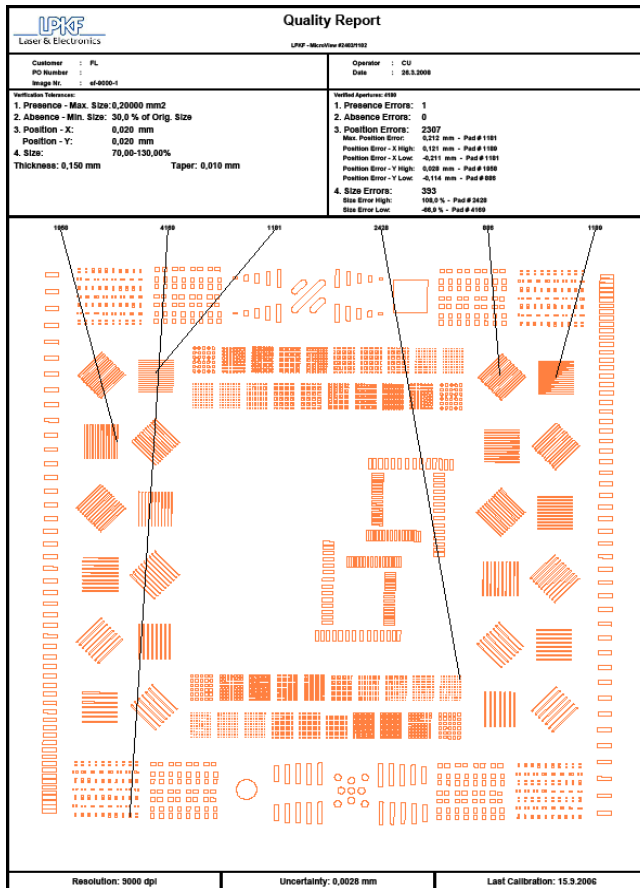

Electroformed (left) and Fine Grain (right) Stencil Aperture Registration Accuracy
2,307 position errors with the electroformed stencil and 27 with the Fine Grain stencil

Conclusion

As advancements continue in component and PCB technologies, will the stencil technology of today provide current and future solutions to the challenging assembly issues faced by OEMs and CMs? Is electroformed technology the right solution or have new developments in stencil laser and material technologies caught up with and surpassed the electroformed technology of today?

The answer to these important questions is in our view an unequivocal “yes.” Stencil laser and material technologies have advanced to the point where laser-cut stencil performance is beyond that of current electroformed technology. Using the new LPKF high-power short-pulse fiber laser technology and the new Fine Grain material, stencil performance is significantly improved over electroformed, especially when printing miniature components. Improvements in stencil laser and material technologies have lead to significant improvements in solder paste release down to a surface area ratio of 0.45 as well as improved aperture registration accuracy. These improvements are critical to meeting future requirements when printing miniature components like 01005s. The technology summary is as follows:

Stencil Technology Summary

Technology	Minimum Surface Area Ratio	Cost	Material	Aperture Registration Accuracy
Chemical Etch	0.66	Low	SS, Alloy	Moderate
Traditional Laser-Cut	0.66	Low	SS, Alloy	Very High
Traditional Laser-Cut	0.55	Low	Slic™	Very High
Electroformed	0.5	High	Electroformed Nickel	High
Advanced Laser-Cut	0.45	Medium	Fine Grain	Very High

At a cost savings of 30-50 percent compared to electroformed, the ability to produce multi-thickness (step) stencils, and the option of same day turn times, Fine Grain stencils, cut with the new fiber lasers, are a marked improvement compared to the high-performance stencil solutions available today. OEMs and CMs can get the performance they need while reducing costs and meeting critical delivery schedules. The new stencil laser and material technologies available today give stencil manufacturers the tools and materials needed to supply an ever-changing industry for many years to come.

ACKNOWLEDGEMENT

The authors would like to thank Stephan Schmidt and Sebastian Gerberding of LPKF Laser Electronics (www.lpkfusa.com) for their contribution to this article.